

- 1. text
- 2. dimension
- 3. wall
- 4. floor/windows
- 5. railing
- 6. roof/slope
- 7. barrier
- 8. detail grid
- 9. paper edges
- 10. section

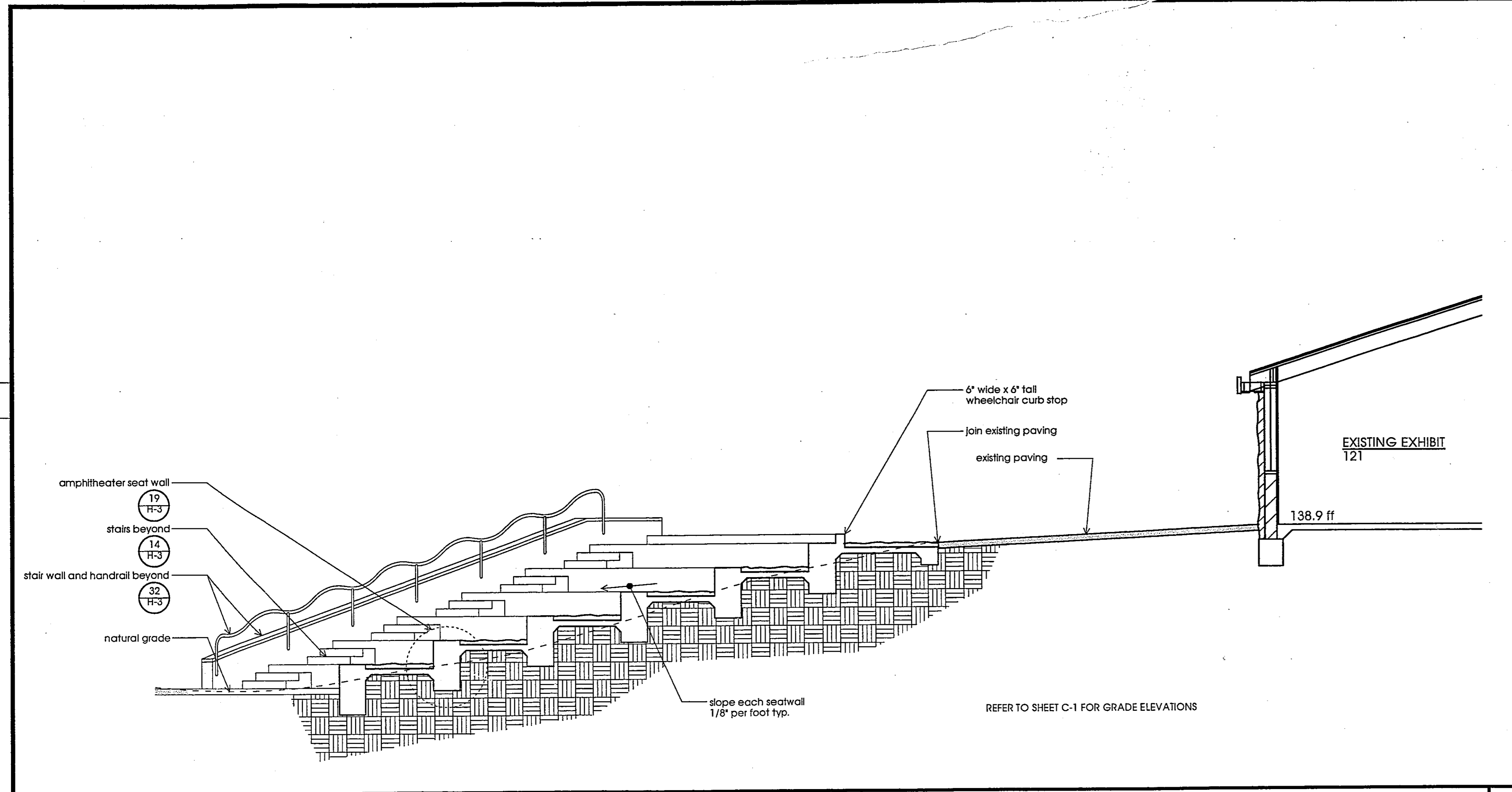

AMPHITHEATER SECTION

Scale: 1/4" = 1'-0"

A

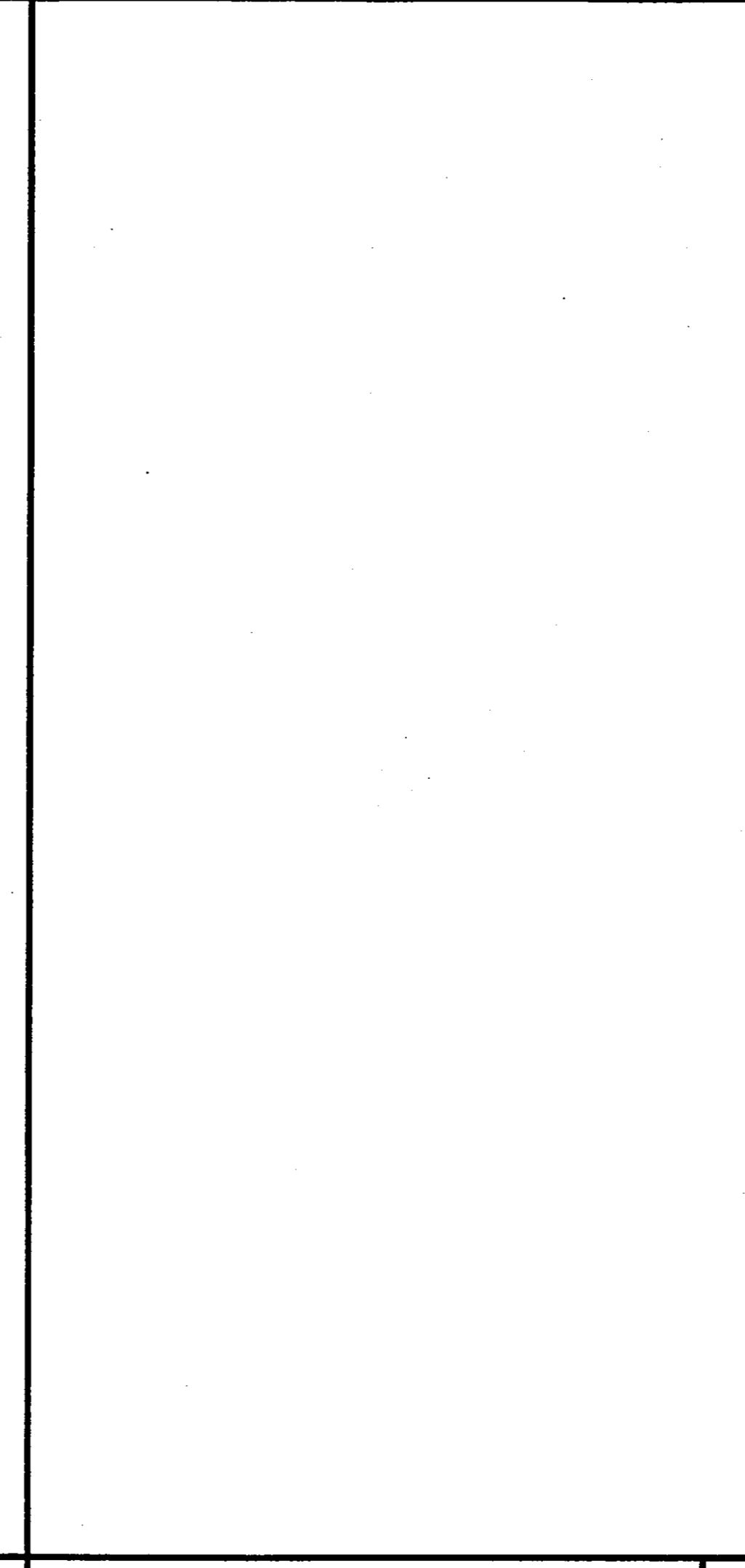

AMPHITHEATER STAIRS & HANDRAIL

Scale: 1 1/2" = 1'-0"

12

95120-h301

Scale: 1 1/2" = 1'-0"

14

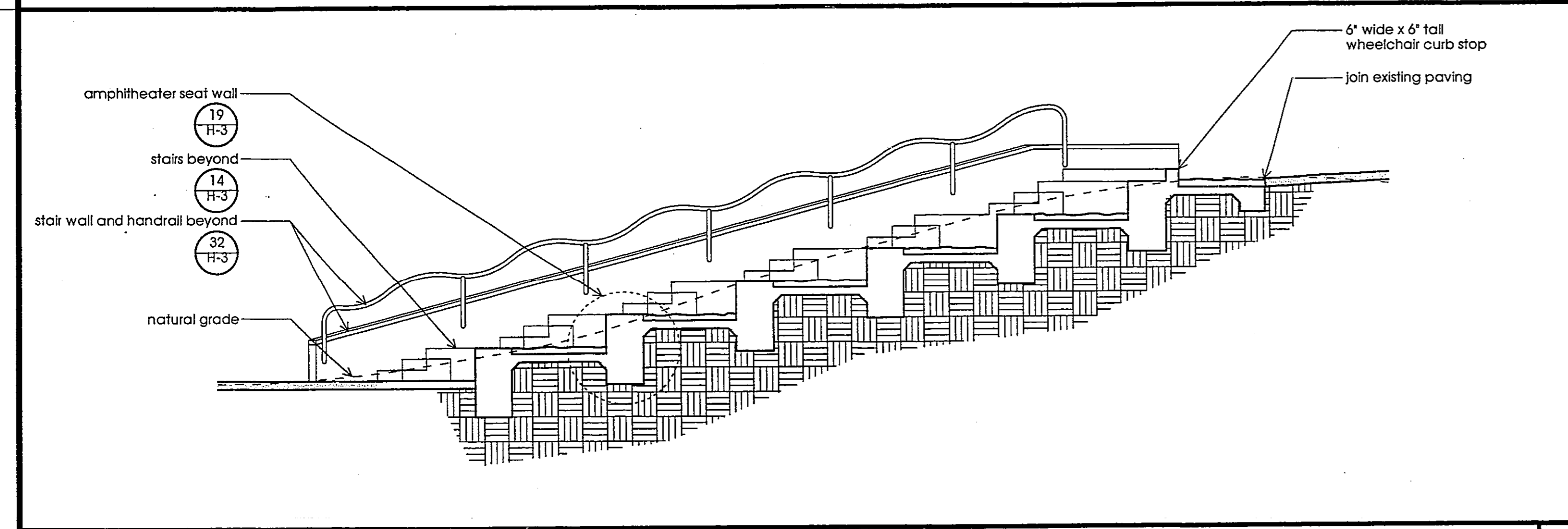

AMPHITHEATER SECTION

Scale: 1/4" = 1'-0"

B

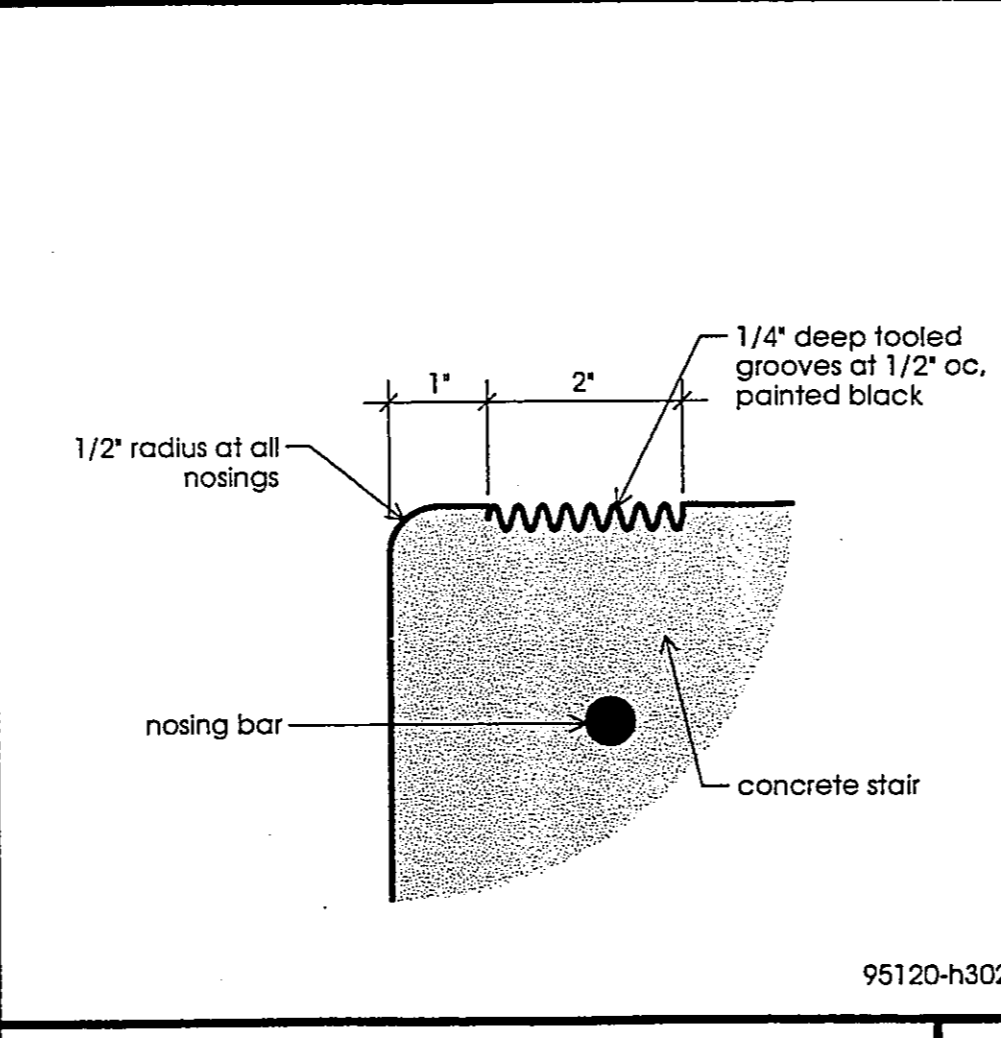

STAIR NOSING

Scale: 6" = 1'-0"

18

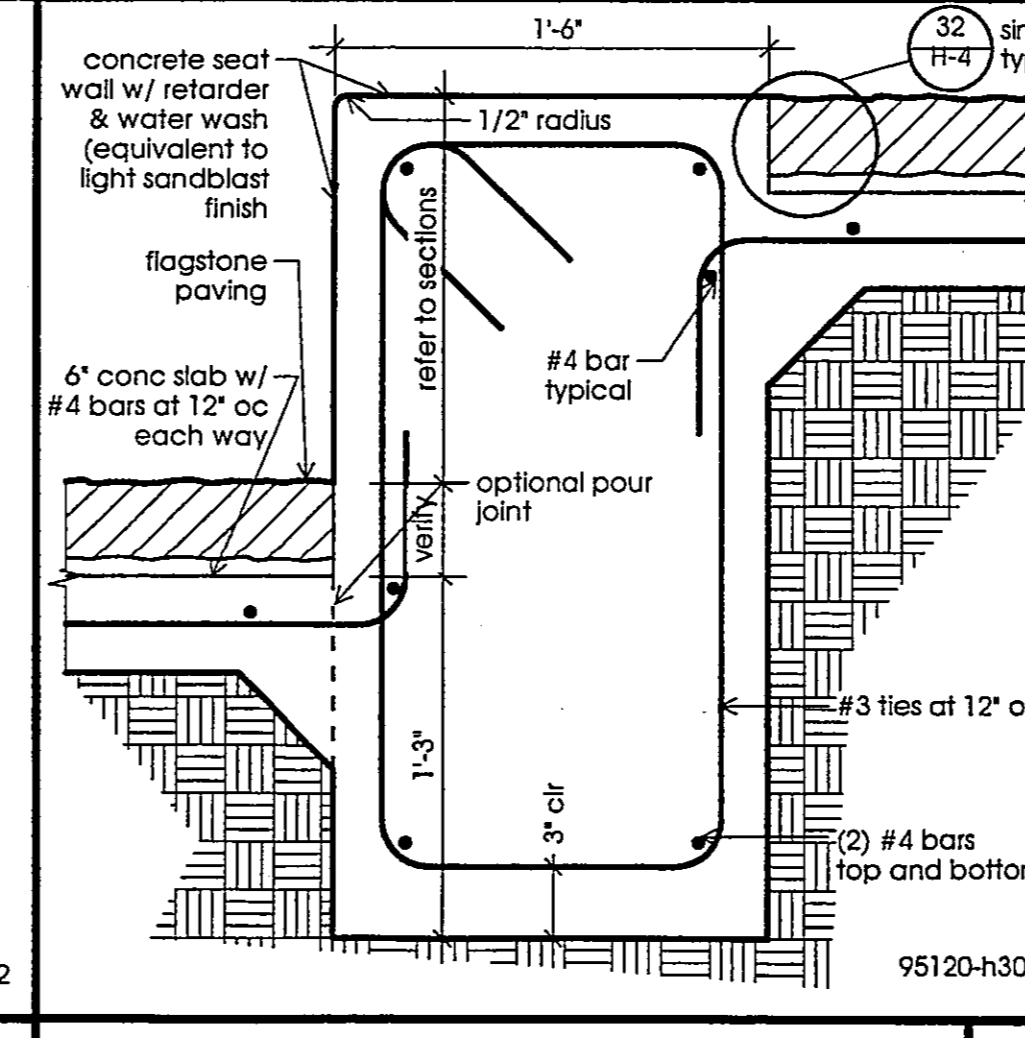

SEAT WALL

Scale: 1 1/2" = 1'-0"

19

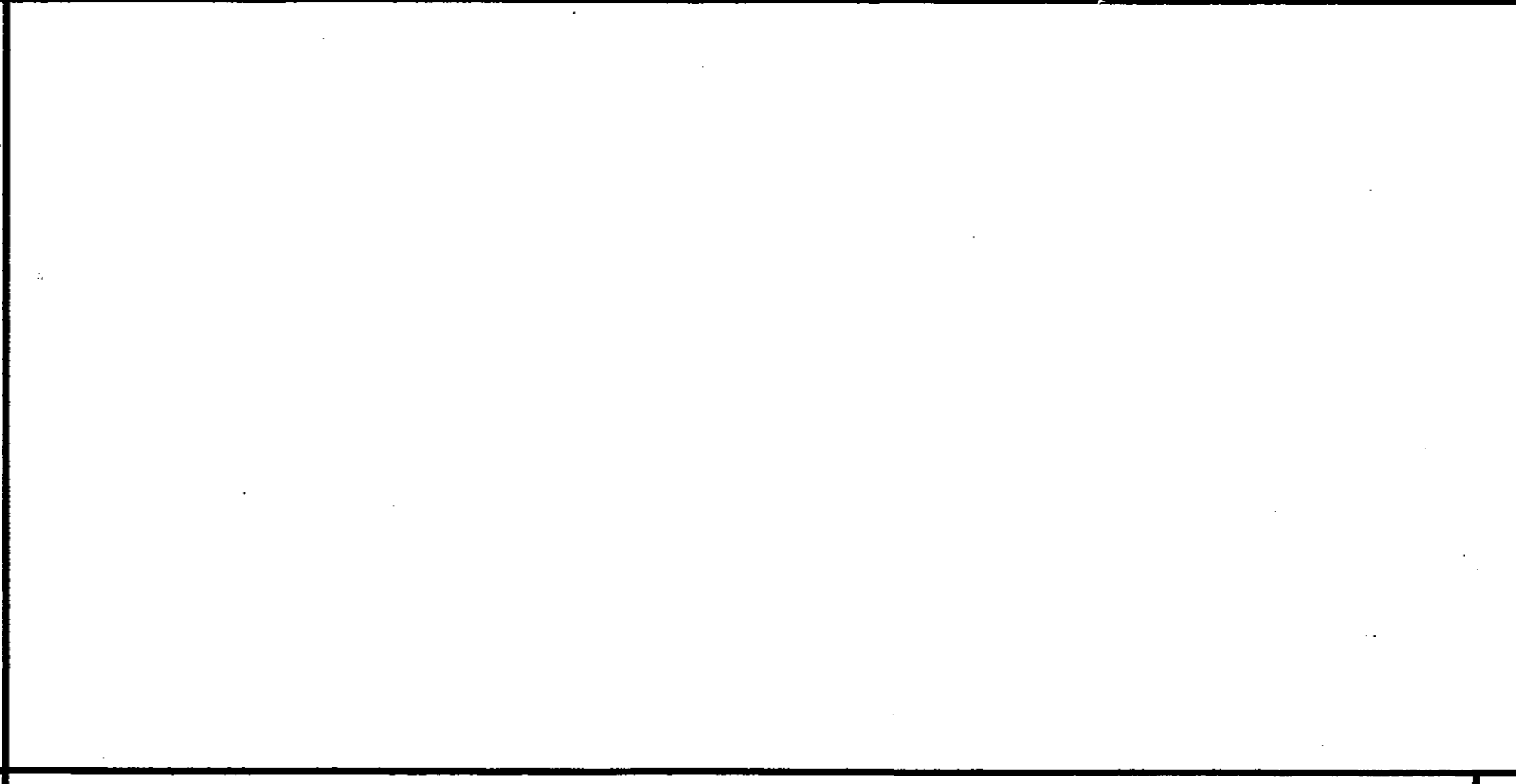

DETAIL TITLE

Scale: 1 1/2" = 1'-0"

33

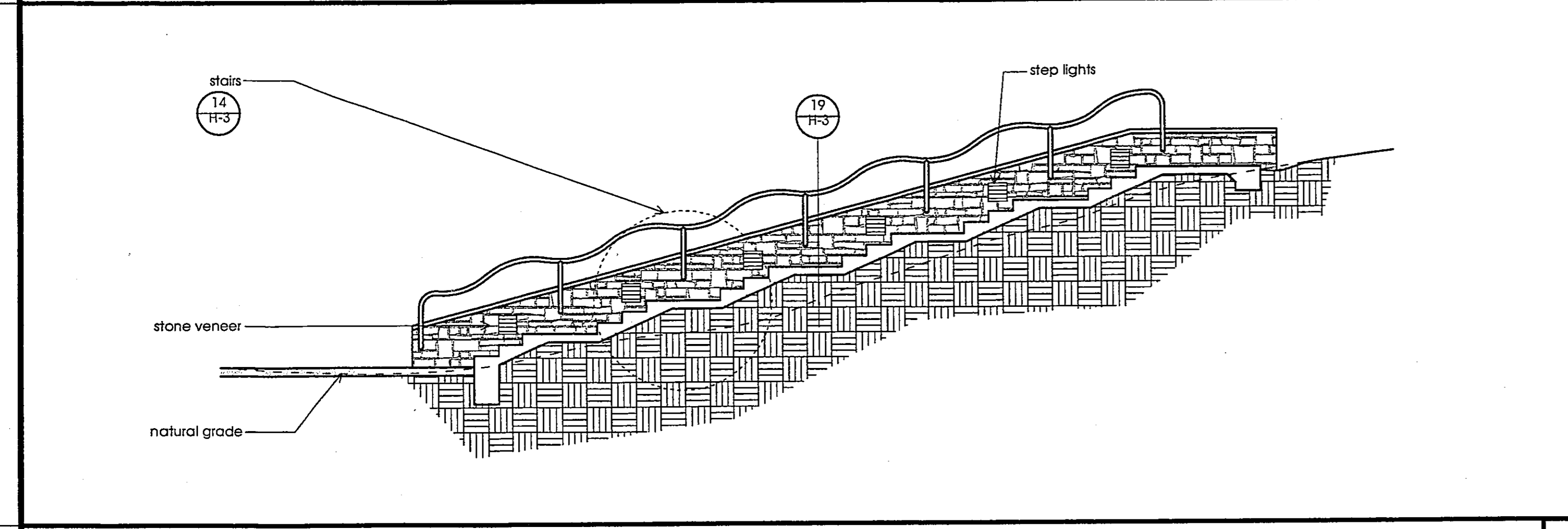

AMPHITHEATER SECTION

Scale: 1/4" = 1'-0"

C

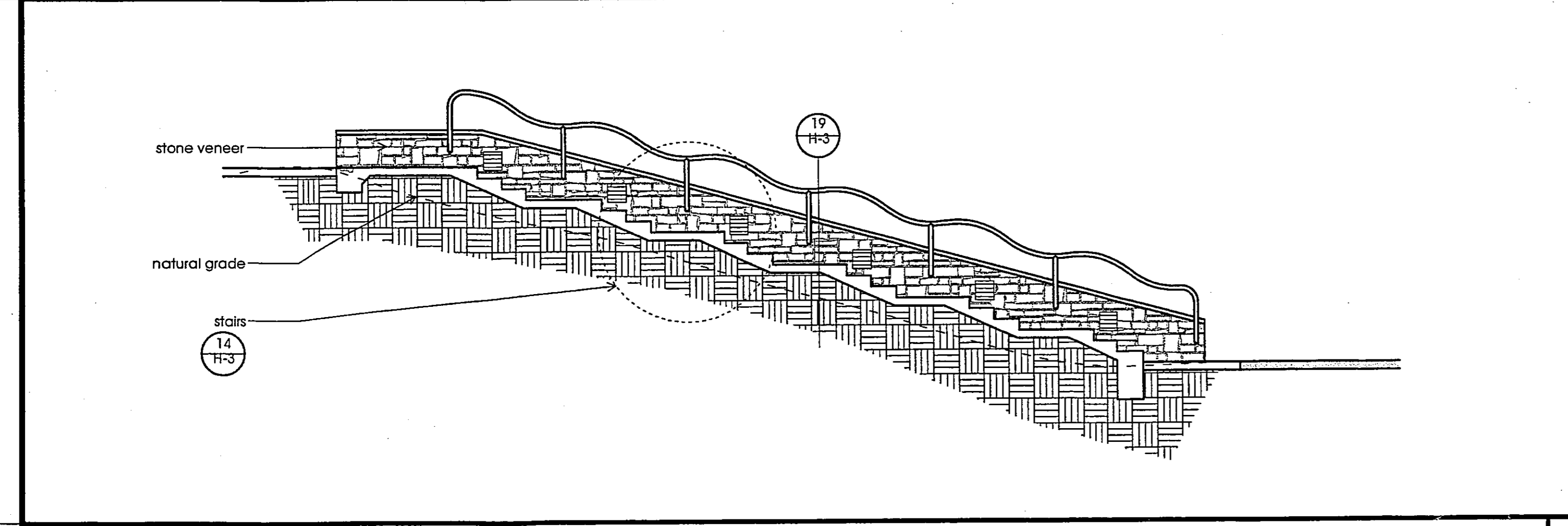

AMPHITHEATER SECTION

Scale: 1/4" = 1'-0"

D

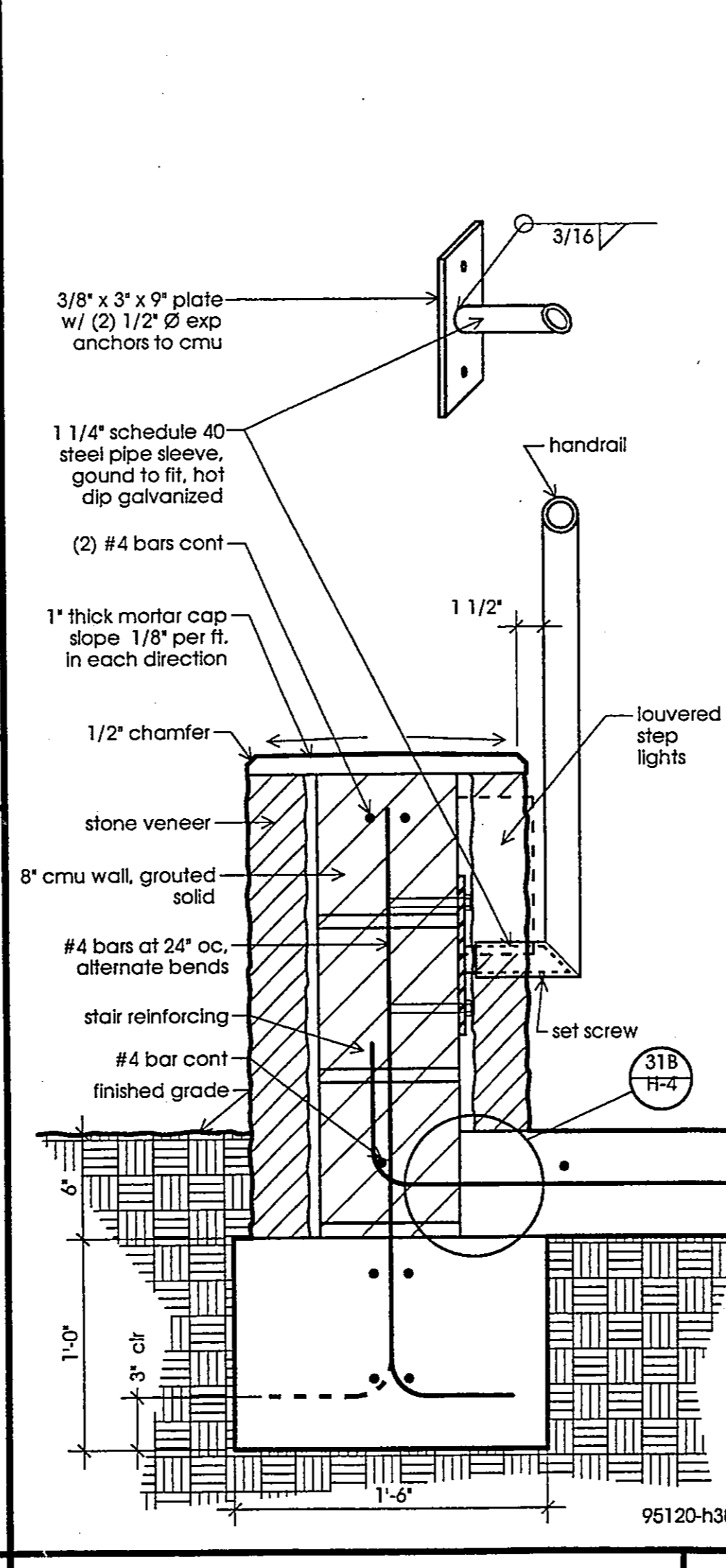

AMPH. STAIR WALL

Scale: 1 1/2" = 1'-0"

32

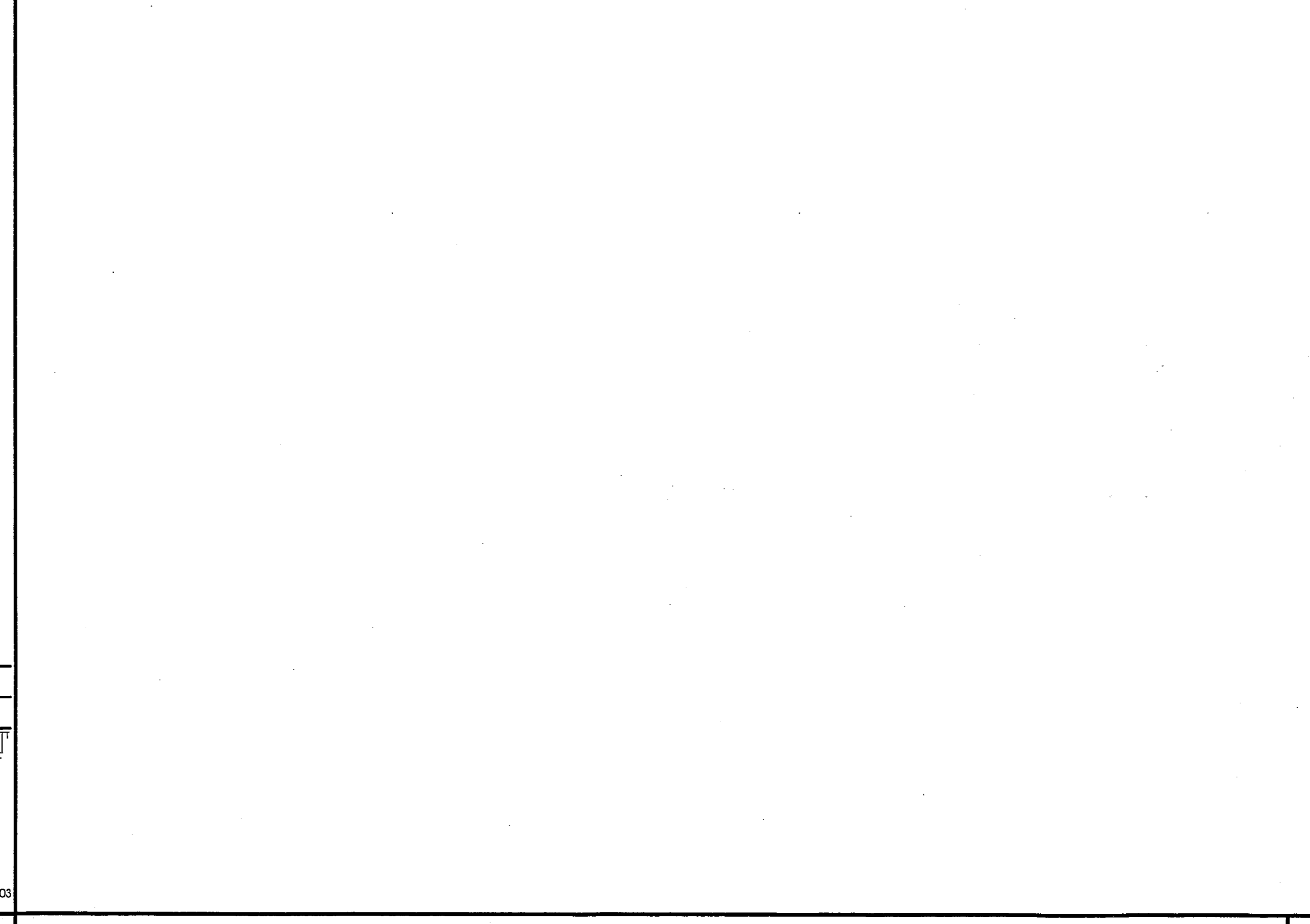

DETAIL TITLE

Scale: 1/4" = 1'-0"

35

RON YEO, FAIA ARCHITECT, INC.  
800 JASMINE AVENUE, CORONA DEL MAR  
CALIFORNIA 92625 P: 714-664-8111 F: 714-664-0449  
PATRICK MARR, AIA, P.E., ASSOCIATE ARCHITECT

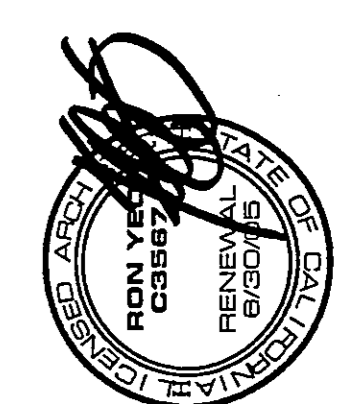

12/23/03 update revisions

POINT VICENTE INTERPRETIVE  
CENTER EXPANSION  
371501 Palms Verdes Drive West  
Rancho Palms Verdes, CA

Hardscape  
Details  
& Sections

DRAWN	PM/MG
CHECKED	RY
DATE	2/1/99
SCALE	(as noted)
JOB NO.	95-120
SHEET	

H-3  
4 OF 61 SHEETS

Ron Yeo, Architect Inc. expressly warrants that the information contained on these drawings was prepared by or under the direct supervision of a licensed professional architect. Any use of these drawings for any other project without the express written consent of Ron Yeo, Architect Inc. is prohibited.

12/29/03

Construction  
PILE EXPANSION  
371501 Palms Verdes Drive West  
Rancho Palms Verdes, CA